

MICROTECH 6 CYL SEQUENTIAL ENGINE MANAGEMENT SYSTEM

N.B.
PER INJECTOR BANK
USE ONLY INJECTORS
1 X 2 OHM INJECTORS
2 X 12 OHM INJECTORS
4 X 12 OHM INJECTORS

MT-8 UER 2 PIN-OUTS

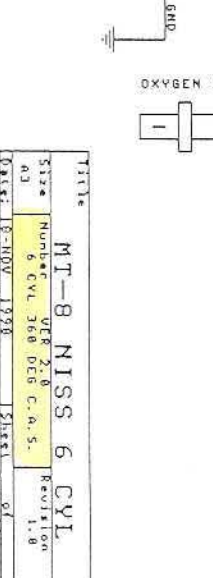
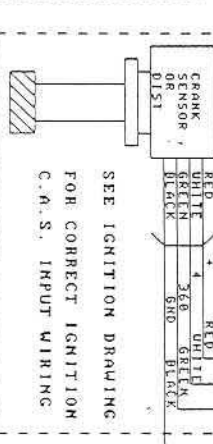
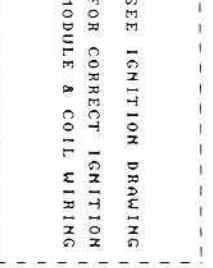
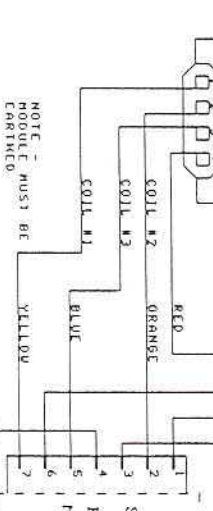
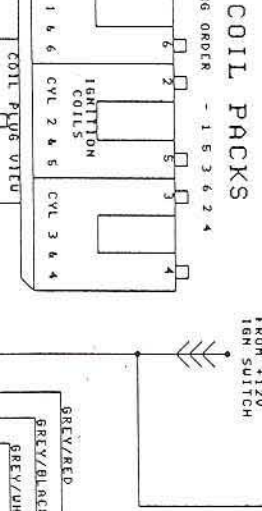
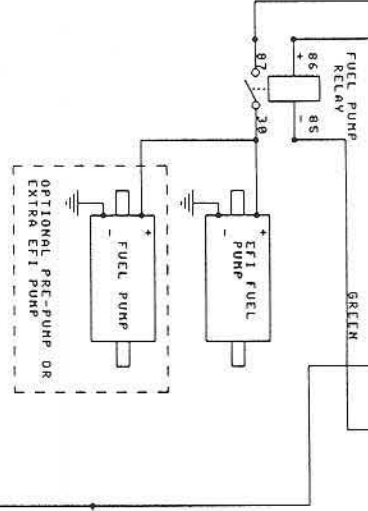
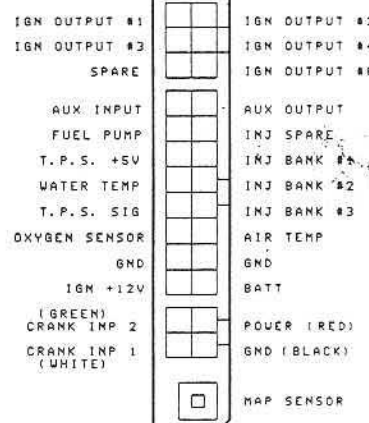

NOTE - MODULE MUST BE CARBINED

MT-8 NISSA 6 CYL
 Size: 2.8 C.A.S.
 6 CYL 3.6L D68
 Date: 11/8/82
 Rev: 01

